

**FICHE D'HOMOLOGATION
HOMOLOGATION FORM**

Homologation N°

9/CA/20



**COMMISSION INTERNATIONALE
DE KARTING – FIA**



CARENAGE AVANT / FRONT FAIRING

Constructeur	<i>Manufacturer</i>	OTK KART GROUP srl
Marque	<i>Make</i>	OTK
Modèle	<i>Model</i>	M6
Catégorie	<i>Category</i>	Toutes / All
Durée de l'homologation	<i>Validity of the homologation</i>	6 ans / years
Nombre de pages	<i>Number of pages</i>	3



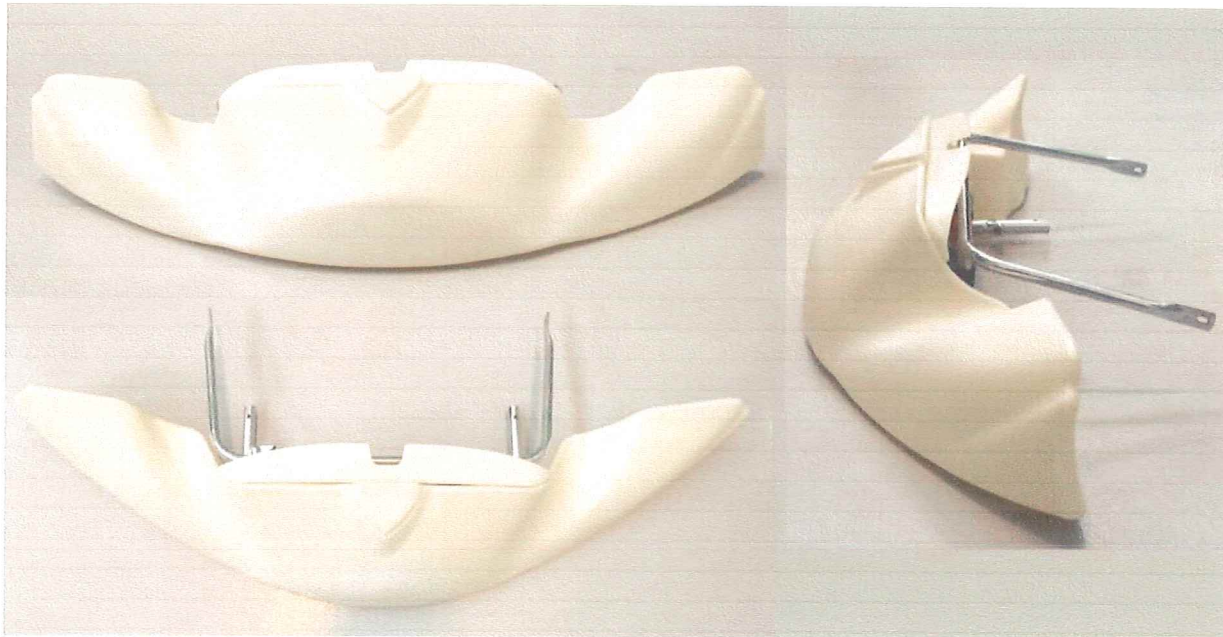

La présente Fiche d'Homologation reproduit descriptions, illustrations et dimensions au moment de l'homologation CIK-FIA.

This Homologation Form reproduces descriptions, illustrations and dimensions at the moment of the CIK-FIA homologation.



PHOTOS VUE DE DEVANT, DE DESSUS ET DE COTÉ, DU CARENAGE AVANT AVEC SUPPORTS

PHOTO FROM FRONT, ABOVE AND SIDE OF FRONT FAIRING WITH SUPPORTS

Signature et tampon de l'ASN <i>Signature and stamp of the ASN</i>	Signature et tampon de la CIK-FIA <i>Signature and stamp of the CIK-FIA</i>
 	  

CARÉNAGE AVANT AVEC SUPPORTS
 Dessin technique (dimensions d'encombrement –
 matériau, diamètre et épaisseur des tubes supports)

FRONT FAIRING WITH SUPPORTS
 Technical drawing (fairing main external
 dimensions – supports material, diameter and wall
 thickness)

Masse en g (carrosserie seule)

Mass in g (bodywork only)

1900 g

+/-10 %

Masse en g (support seul)

Mass in g (support only)

1320 g

+/-5 %

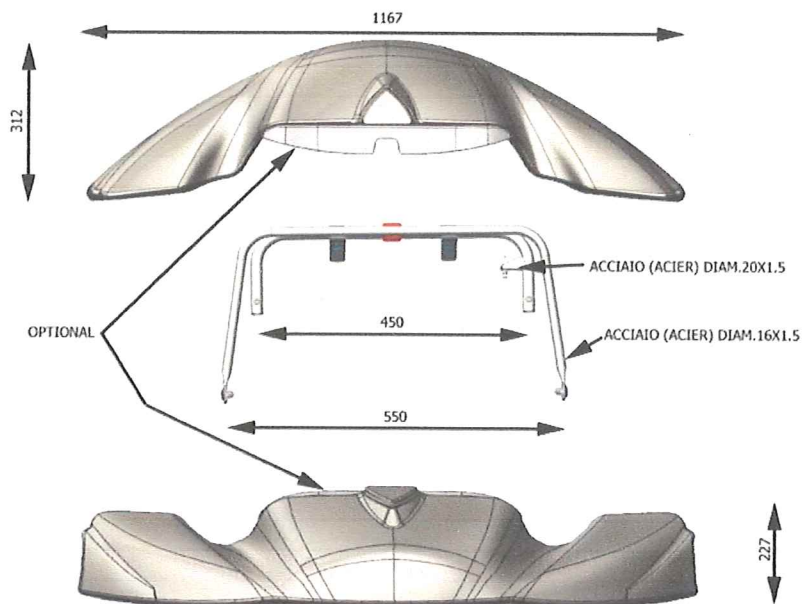

PHOTO (complet avec supports) / (complete with supports)



FIXATION CARÉNAGE AVANT
Dessin technique éclaté

FRONT FAIRING ATTACHMENT
Exploded technical drawing

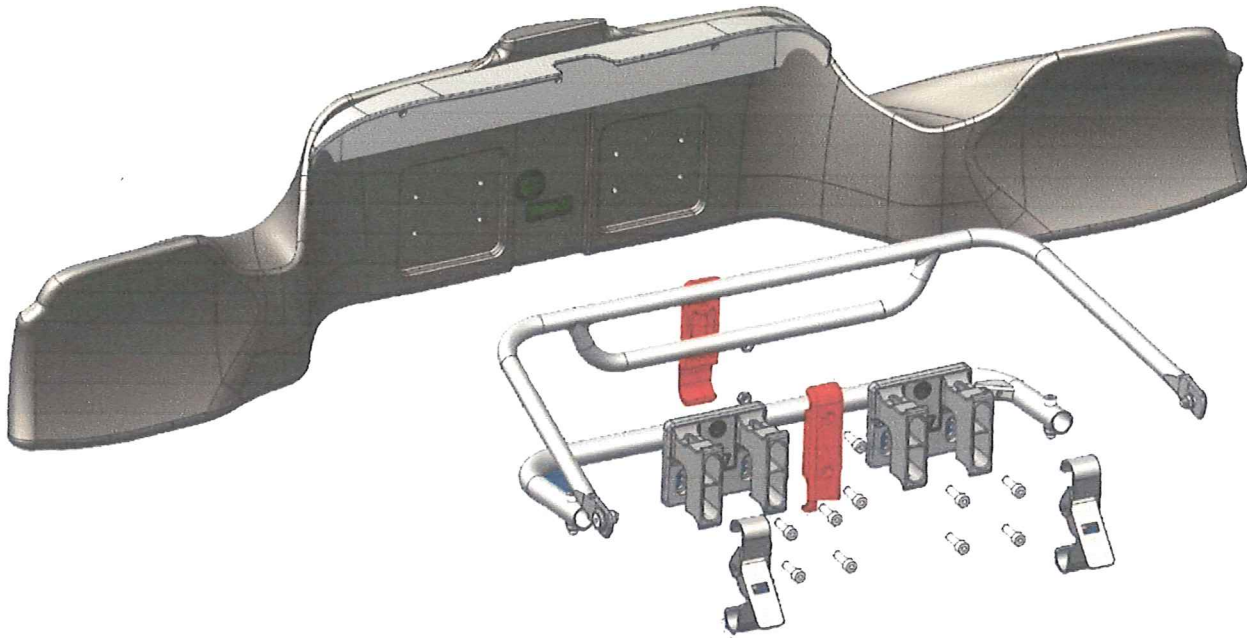

PHOTO DU MARQUAGE DU NUMERO
D'HOMOLOGATION (et du logo CIK-FIA sur les
éléments plastiques)

PHOTO OF THE HOMOLOGATION NUMBER
MARKING (and of the CIK-FIA logo on the
plastic parts)

Le marquage doit rester clairement visible en permanence
The marking must be clearly visible at all times

